

14.85 cm

RubineTM
I T A L I A

REDEFINE THE WAY OF LIFE

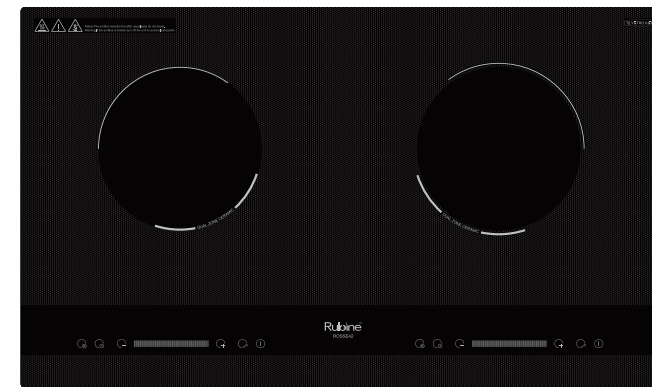

21 cm

USER MANUAL

MODEL

RCE-ROSSE42-BL

SERIAL NO.

BUILT-IN CERAMIC HOB

14.85 cm

Contents

Caution and Safety Warning	1
Parts & Features	3
Technical Specification & Installation	4
How to use	5
Cleaning & Maintenance	7
Troubleshooting Guide	8

⚠ Self-diagnostic Function

The product will be alarm, then automatically shut down or stop to heating. And the product also displayed error code. If the problem can not be solved please consult the service centre and do not try to throw off the unit by yourself.

The error code list as below :

⚠ ERROR CODE LIST :

- E0 : The voltage is too low.
- E1 : The voltage is too high.
- E2 : The temperature on cooker surface is too high.
- E3 : The IGBT temperature is too high.
- E5 : The temperature sensor for cooker surface is short circuit or open circuit.
- E6 : The temperature sensor for IGBT is short circuit or open circuit.
- E7 : No cookware/pan put on hob surface

21 cm

Troubleshooting guide

Difficult explanation

Symptoms	Possible Cause	Solutions
Display flashing when connect electric	Work smoothly	No problem
The fans still run a few minutes after turn off the products	Cooling the temperature for heat inside hob	No problem
The item surface still keep warm, even after switched off	Heat residual display 'H'	No problem
No work and no display	Not connected electricity or no electricity	Ensure all everything supply working well
The display work normally but can't operate	The problem of PCB	Contact after-sales service department.
Open one burner, the display shows "E7" with buzzing	The pot not suitable for induction cooking	Change to other suitable pot
The pot have noise during cooking	The noise is vibration which is from the induction cooker imparted energy to pot	No problem
The induction cooker have taste in the first time use	It is a new appliances	Boil water for half an hour to remove abnormal smell on pot

Built-in Ceramic Hob

⚠ Caution

Before use

- Thanks for your purchasing at our product.
- Please take note that this product is for indoor household use only.
- Please read this instruction manual carefully before using the product in order to ensure safe and correct use of this product.

⚠ INSTRUCTIONS FOR USE

1. This appliance is not suitable for persons (including children) with reduced physical, sensory or mental capabilities or lacking in experience and knowledge, unless they have been given supervision or instruction concerning the use of the appliance in a safe way, and understand the hazards involved.
2. If you have been fitted with a cardiac pacemaker, please consult your doctor for advice on whether or not it is safe for you to operate this appliance.
3. Do not allow children to play with the appliance.
4. Do not let children clean and/or maintain this appliance unless they are strictly supervised with clear instructions.
5. Before installing, maintaining, and repairing this appliance, make sure to disconnect the power supply first.
6. DO NOT use the appliance if the power cord or the power plug has been damaged, or if the interface between the power sockets and the power plug is loose.
7. If the power cord is damaged, in order to avoid risk of bodily injuries, it must be replaced by the manufacturer i.e. its technicians, maintenance professionals or similar.
8. DO NOT damage either the power cord or power plug.
9. DO NOT immerse cord, plug or unit in water or any other liquids.
10. DO NOT allow the wire cord to hang over the edge of the table or counter, or any heated surfaces.
11. DO NOT use extension cords to operate the appliance; use individual electric supply socket.
12. Make sure that the appliance and its corresponding electrical components are installed correctly before use.
13. DO NOT alter, dismantle or repair the appliance without the express consent of the manufacturer; all unauthorized attempts to do so is prohibited to ensure user safety.
14. Make sure to use this appliance on a firm, flat and heat resistant surface.
15. DO NOT place near hot gas.
16. When using this appliance, basic safety precautions should always be followed; check the voltage indicated on the rating plate corresponds with that of your local voltage before connecting the appliance to the main power supply.
17. When the power is switched ON, this appliance will get very hot; be careful when using to avoid scalding and burning.
18. DO NOT use the appliance to cook explosive food.
19. DO NOT place any metal contents on the appliance while operating.
20. DO NOT touch the control panel with any sharp objects.
21. In case of operational abnormalities or malfunctionings, please stop using it and pull out the power plug immediately.
22. Allow to cool before putting on or taking off parts, and before cleaning.
23. DO NOT use cleaners containing irritants or with corrosive detergents, or sharp metal scrapers to clean the appliance.

14.85 cm

Built-in Ceramic Hob

⚠️ ADDITIONAL IMPORTANT NOTES

1. Connect this appliance to a 220-240V electrical outlet only.
2. When this appliance is in use:
 - a) DO NOT allow curtains, wall coverings, clothing, dish towels or any other flammable materials be in close proximity;
 - b) DO NOT place cleaning agents, solvents or any other flammable liquids anywhere near;
 - c) DO NOT leave unattended; and
 - d) DO NOT under any circumstances cover the gas vent.
3. If any cracks are detected on the surface, shut down the appliance immediately to avoid the risk of injuries from electrical shock.

⚠️ WARNING



1. Misuse of this appliance may cause injuries.
2. DO NOT heat empty pots on the heating zone.
3. DO NOT put pressure on the heating plate to avoid possible impact damage.
4. The temperature of all accessible surfaces may be high when the appliance is in use; exercise caution to avoid scalding and burning.
5. The glass plate is hot after use, please DO NOT touch; exercise caution to avoid scalding and burning.
6. DO NOT switch OFF the power supply immediately after use; wait at least 30 seconds for the Cooling Fan to work on cooling the appliance.
7. Always switch OFF the appliance before leaving it unattended.

Cleanness and maintenance

After Use

1. Please turn OFF and unplug the appliance before starting any cleaning or maintenance work.
2. Please leave the appliance to completely cool before cleaning.
3. Please use soft cloth for cleaning stains on glass plate and panel.
4. Please use damp cloth and mild detergent for cleaning grease stains and blots.
5. DO NOT use high voltage vacuum cleaner or air cleaner to clean the appliance.
6. Please clean gas vent regularly to prevent the accumulation of dust and dirt.
7. Always check to make sure that connection between appliance plug and power socket is fast and secure before using.
8. DO NOT pull the power cord to unplug.
9. Please note that Cooling Fan will still be operating after power is turned OFF and appliance is left to cool.
10. Please check to make sure that the bottom of cooking pots or pans are not rough and uneven to avoid possibly scratching the glass panel.
11. DO NOT place hot pots and pans on any non-heating areas of the appliance.

21 cm

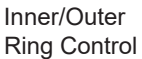
- c) Slide 
- i) Use to adjust the "Power" level:
- "Slide" from left to right to increase power to a higher level; and
 - "Slide" from right to left to decrease power to a lower level
 - Power levels are on a scale of 1-9
- d) Timer 
- i) Use to adjust the "Timer":
- Turn ON the appliance;
 - Select your desired "Power" level;
 - Press "Timer" to set cooking duration
 - Press "+" or "-" to select cooking time--selected duration will be displayed on the LED screen for a few seconds, after which the appliance will start counting down;
 - Once the set cooking duration is reached, the appliance will automatically turn OFF
 - Timer : 0-99 mins
- e) Lock
- i) Use to lock the Control Panel:
- Press and hold for about 3 seconds to activate the "Lock" function; all buttons are now locked except ON/OFF
- ii) To unlock:
- Press and hold again for about 3 seconds to deactivate the "Lock" function;
- f) Inner/Outer Ring Control  Ceramic Cooker(Right side)
- i) Use to select the inner, outer or both inner and outer heating zones for Ceramic Cooker ONLY:
- Turn ON the appliance;
 - Select your desired Power level;
 - Press "Inner/Outer Ring Control" to select either inner, outer or both heating zones

Parts and features

Built-in Ceramic Hob

Before Use

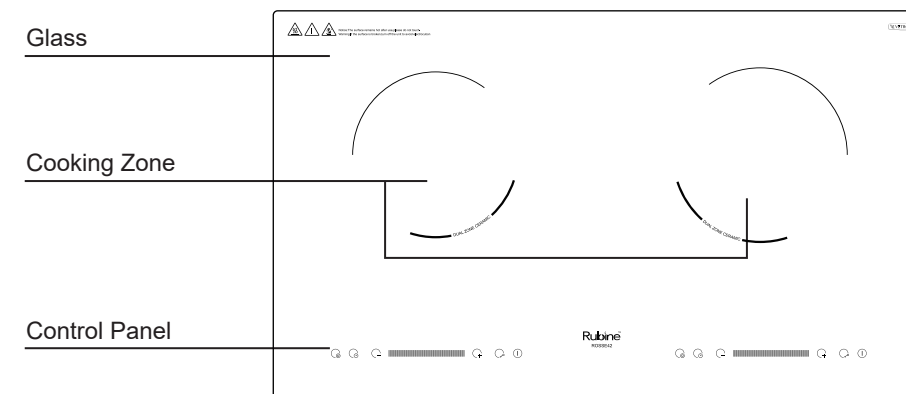

Ceramic Cooker Control Panel

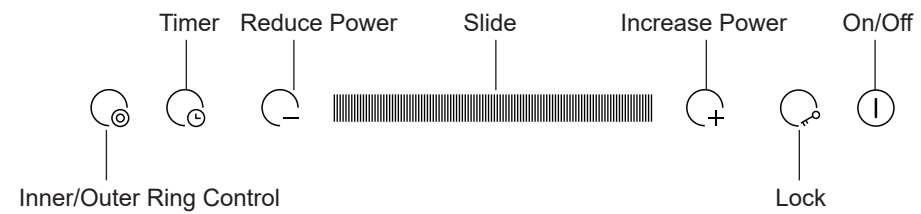

21 cm

Technical Specification

Before Use

Model	RCE-ROSSE42-BL
Voltage	220-240V
Rated Power	4200W
Rated Frequency	50-60Hz
Product Size (mm)	730 (W) x 430 (D) x 60 (H)

Installation

Before Use

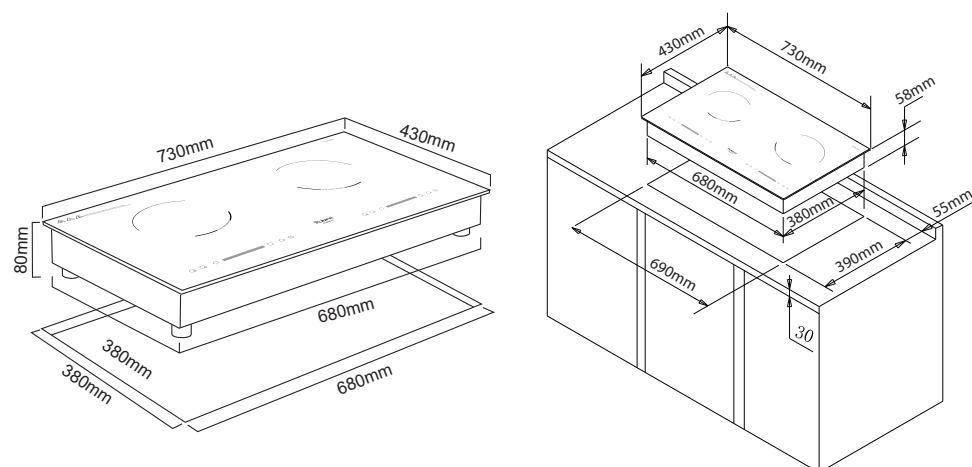

Installation

This appliance must be installed by trained experts with the technical know-how to check and determine that:

1. Table/cabinet for installing the appliance is made of heat resistant materials to avoid the risk of melting and/or deformations, as well as possible damage to the appliance;
2. Glue/binder in table/cabinet made of polywood can withstand a temperature of at least 120° Celsius to avoid the risk of melting and/or deformations, as well as possible damage to the appliance;
3. Surrounding walls can withstand all the heat emanating from the appliance when it is in use;
4. Exact measurements for cutting into the table/cabinet (see diagram) are followed;
5. Space of at least 50mm wide and 30 mm thick around hole in the table/cabinet is made for easy installation, and operation of the appliance;
6. Appliance is not installed in close proximity to other cooking systems, dishwasher or rotary drying machines; and
7. There is $\geq 10\text{cm}$ of free space to prevent overheating.

4

How to use

Use process

1. Cookware Selection

- a) i) CERAMIC HOB - Steel, cast iron, enameled iron, stainless steel, and ceramic cookware

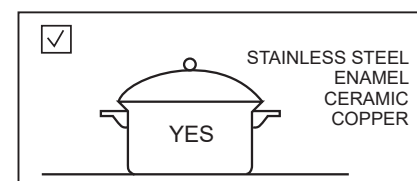

- ii) INDUCTION HOB - the cookware must have an iron base

- iii) Aluminium pot or pan is NOT recommended.

- b) Flat-bottomed pot or pan

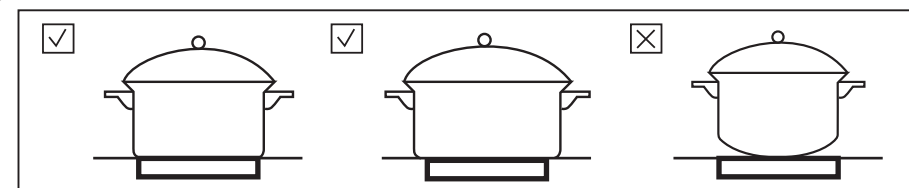

- c) Flat-bottomed pot or pan 12cm to 26cm in diameter

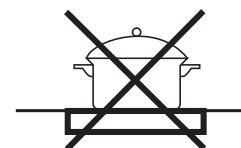

Note: Please select the most suitable pot or pan for Ceramic or Induction use.

- d) DO NOT use tinfoil or plastic cooking materials, as these may melt, and possibly leave permanent marks on the glass surface.

2. Caution

Avoid dragging pots and/or pans across the panel to avoid possibly scratching the glass.

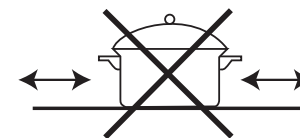

3. Control Panel Operation Instruction

- a) ON/OFF \cup

- i) Press to turn the the appliance power ON or OFF
- ii) Once "ON/OFF" is pressed, the appliance will emit a 'BEEP' sound, and the red light will turn ON
- iii) The appliance is now in "Standby" mode; you may select your desired power for heating
- iv) If no operation is selected in 10 seconds, the light will go off
- v) Press "ON/OFF" again to turn OFF the appliance; red light will turn OFF too.

- b) i) Press to adjust the "Power" or "Timer":

- + • "+" to increase "Power" or "Timer" to a higher level; and
- "-" to decrease "Power" or "Timer" to a lower level

21 cm

5

