

Customer Care

AFTER-SALES SERVICE:

Exact Quality Sdn. Bhd.

Hotline: **03-6286-9000**

Email: **eqservice@fiamma.com.my**

OPERATION HOURS

08:30am - 06:00pm

(Monday - Friday, except public holiday)

Our Warranty

6 yrs
Warranty

FOR HOOD MOTOR ONLY

18 mths
Warranty

FOR ALL PARTS
(EXCLUDING ACCESSORIES)

1 yr
Warranty
Extension

**1-year
Warranty
Extensions
When Register
Online!**

Online Registration

1. Log on to www.rubine.com.my
2. Click on 'Support', followed by 'Products Warranty Registration' to proceed. You're required to sign up as a member.
3. Please fill up the necessary information, tick on the checkbox and click 'Next'.
4. You'll receive a notification of warranty registration confirmation via email.
5. Your warranty will be automatically extended for another 1 year upon registration online. Please keep your online warranty certificate for reference.

rubine.com.my

RubineTM
I T A L I A

REDEFINE THE WAY OF LIFE



USER MANUAL

MODEL

RCH-MONZA X-BL

SERIAL NO.

COOKER HOOD



FIAMMA TRADING SDN BHD 330476-P (A member of Fiamma Holdings Berhad)

9-2, Wisma Fiamma, No.20, Jalan 7A/62A, Bandar Manjalara, 52200 Kuala Lumpur. Tel: 03-6279 8943

WARRANTY CARD

WARRANTY CONDITIONS

Subject to following Term & Conditions, this equipment is guaranteed against defective material & manufacturing defects by Fiamma Trading Sdn Bhd for a period of twelve (12) months from the date of original purchase. Fiamma Trading Sdn Bhd reserves the right to change these terms & conditions without prior notice.

Terms & Conditions:-

- 1) This warranty is valid & provided that warranty card is completed with authorized dealer's stamp from the date of original purchase and in the territory of Malaysia only.
- 2) This warranty covers repair or, at the option of Fiamma Trading Sdn Bhd, replacement of any parts proven to be defective due to defective workmanship or material provided that the product was purchased from an authorized dealer of Fiamma Trading Sdn Bhd.
- 3) This warranty does not cover the damage resulting from:
 - (a) Any unauthorized disassembly, service repair, alteration or modification being carried out.
 - (b) Abnormal voltage or the use of generator and/or used not in accordance with the Operating Manual / User Manual.
 - (c) Misuse, abuse, negligence or accident howsoever caused.
 - (d) Normal wear or tear.
 - (e) Rough handling & transportation.
 - (f) Commercial / public use e.g. hotel, laundry, college, university, etc.
- 4) This warranty does not cover the following accessories:
 - (a) Burner Caps/Supports (b) Cast Iron Grib (c) Knobs (d) Body Work (e) Light Bulb (f) Charcoal / Filter (g) Cover (h) Glass Cover / Screen (i) Trays/Shelves (j) Hose
- 5) This warranty is considered null & void in the events if:
 - (a) Any item contained in this warranty card has been tempered with or altered in any way without the prior written consent of Fiamma Trading Sdn Bhd. Request for warranty services within the warranty period must be accompanied with this warranty card & proof of original purchase.
 - (b) Any time during the warranty period, any part / parts of this equipment is / are removed, altered, tempered with, adjusted, modified, dismantled, repaired or handled in any way whatsoever by any person / persons not authorized by us.
 - (c) The serial number of the product has been defaced or removed.
- 6) Warranty for WINE CHILLER compressor is (5) five years, gas refill and labor charges are excluded.
- 7) In the event of defects covered by this warranty arising during the warranty period, the purchaser shall be fully responsible for the due delivery to our dedicated service centre of the equipment (expect for the refrigerator, washing machine, ovens, cooker hood, gas cooker, dishwasher, dryer, built-in hob, freezer, water heater) for any work which shall need to be done pursuant to this warranty & subsequent collection thereof of the equipment after the said work has been done.
- 8) This warranty is in lieu of any, and all other warranties expressed or implied warranty of merchantability or fitness for a particular purpose. Fiamma Trading Sdn Bhd assumes no liability for the breach of the warranty beyond correcting the breath in the manner described above. In no event shall Fiamma Trading Sdn Bhd be liable for consequential losses or damages, including loss of use or loss of profits resulting from the product.

FOR OFFICE USE

Model Name <input style="width: 90%; height: 20px;" type="text"/>	Serial No Barcode : <input style="width: 95%; height: 40px;" type="text"/>
Customer's Name (In Block/Full Name) _____ _____ _____	
Date of Purchase : <input type="text"/> DAY <input type="text"/> MTH <input type="text"/> YR	
Customer's Address (Full Address) : _____ _____ _____	
PostCode : <input type="text"/> State : _____	
Customer's Tel No : (H) <input type="text"/> - <input type="text"/> (O) <input type="text"/> - <input type="text"/>	
Customer's Email : _____ (H/P) <input type="text"/> - <input type="text"/>	

 Authorised dealer's stamp
 Fiamma Trading Sdn. Bhd.

 Customer Signature

TROUBLESHOOTINGS

CAUTION: Disconnect the power supply before servicing.

STATUS	CAUSE & METHOD OF REPAIRING	TOOL
Damaged of power supply	If the power supply is damaged, please call technician to repair.	“+” type screwdriver sharp pincers
The lamp works but the motor does not run	a) Take off the filter and check the connection between air inlet and wind chamber whether it is sealed or not. b) Check the connection between air exhaust pipe and wind chamber whether there is leakage of oil or not. If YES, please fill it up with the varnish or thinner. c) If the motor stops running and has a bad odor after a moment of operation, the motor wires may be burnout. Please replace motor d) If the starting wire (yellow) is disengaged from the condenser, it needs to be rewired e) If the condenser is damaged, please replace with a new one.	“+” type screwdriver
Machine vibration	a) If the motor were not firmly screwed, tighten the screw up. b) If the vane is damaged or unbalanced, replace with a new one.	“+” type screwdriver
Weak suction	a) The distance is too far between the cooker hood and hob. b) There are many windows (doors) causes strong wind convection. c) If due to the position of cooker hood install upon the window, you may put a three-ply board on the back of the cooker hood to cover the spaces.	“+” type screwdriver “+”
Tilting hood	a) Adjust the height of the model where it is hung on the ceiling. b) If the model tilt forward, lock the wall with wood screw again (the screw peep out around 0.5~1 cm from the wall), or check the screw that fixing the model are loose or not.	“+” type screwdriver
Lamp does not light-up	Take the screw off from the lamp shade and replace with a new light bulb, then fix the lamp shade back.	“+” type screwdriver

Dear valued customer,

Thanks for your purchase of our product.

PLEASE READ & KEEP THIS USER MANUAL

CONTENTS

SPECIFICATIONS	1
PRODUCT DIMENSION	1
PRODUCT PART DIAGRAM	2
INSTALLATION REQUIREMENT	3
INSTALLATION PROCEDURES	4-5
CHARCOAL FILTER INSTALLATION & REPLACEMENT	6
OPERATING INSTRUCTIONS	6-7
MAINTENANCE	8
TO REPLACE LED LAMP	8
IMPORTANT SAFETY INSTRUCTIONS	9-10
TROUBLESHOOTINGS	11
WARRANTY CARD	12



Please note that this product is marked with this symbol:

According to Waste of Electrical and Electronic Equipment (WEEE)

directive, WEEE should separately collect and treat. If in future you need to dispose this product, PLEASE DO NOT dispose it with household waste.

Please send it to WEEE collection point.

SPECIFICATIONS

Model Name:RCH-MONZA X-BL

Total Power:360W

Motor Power:268W

LED Lamp:1×2W

Voltage:220-240V

Frequency:50Hz

Control Panel: Sensor Touch Control

PRODUCT DIMENSION

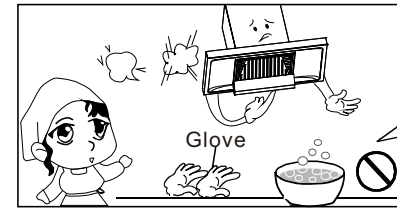
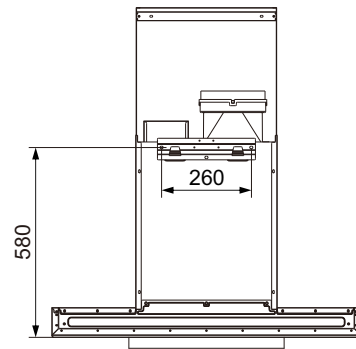
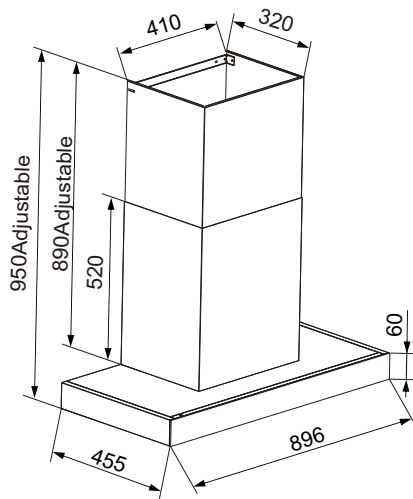

Dress the protective glove before you start to clean the hood. Remove the components gently during carrying out the clearance.

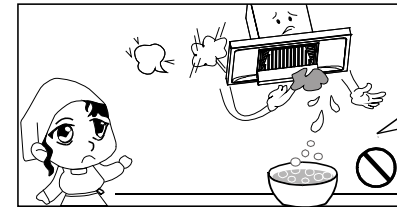

Never wash the control switch with water or other kind of liquid for the liquid might cause electrical problem to the hood.

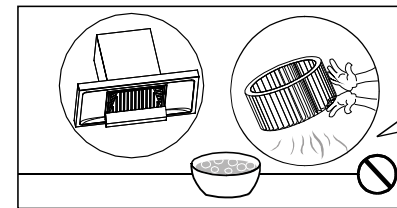

To clean the motor fan should be undertaken by a qualified person, pay top attention to avoid any distortion of the fan during carrying out the clearance.

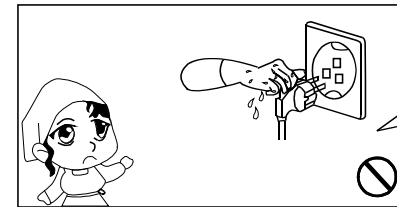

Never pull the plug out of the power supply by wet hand to avoid the possibility of electric shock.

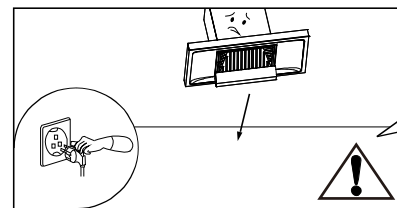

Disconnect the cooker hood from the power supply if this appliance will not be used for a long time.

IMPORTANT SAFETY INSTRUCTIONS:

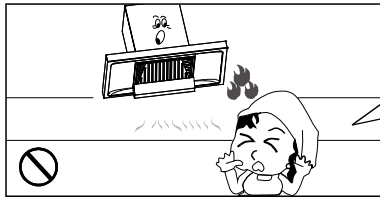

Do not connect the air outlet to chimney flues or combustion gas ducts.

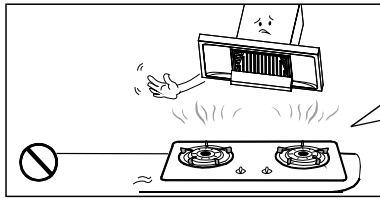

Do not leave naked flames under this hood.

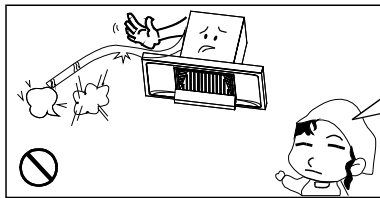

In case of any damage to power cable, replace the broken cable with a new one by qualified person.

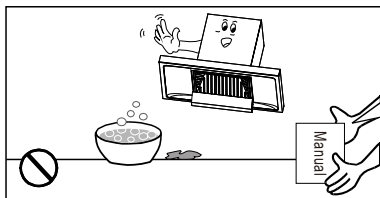

Do clean the hood correctly in accordance with instruction stated or it might cause the possibility of fire accident.

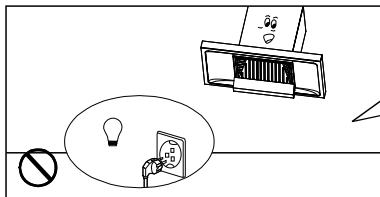

To replace the bulb should be undertaken by a qualified electrician or a competent person. Always use the bulb no more than rating.

PRODUCT PARTS DIAGRAM

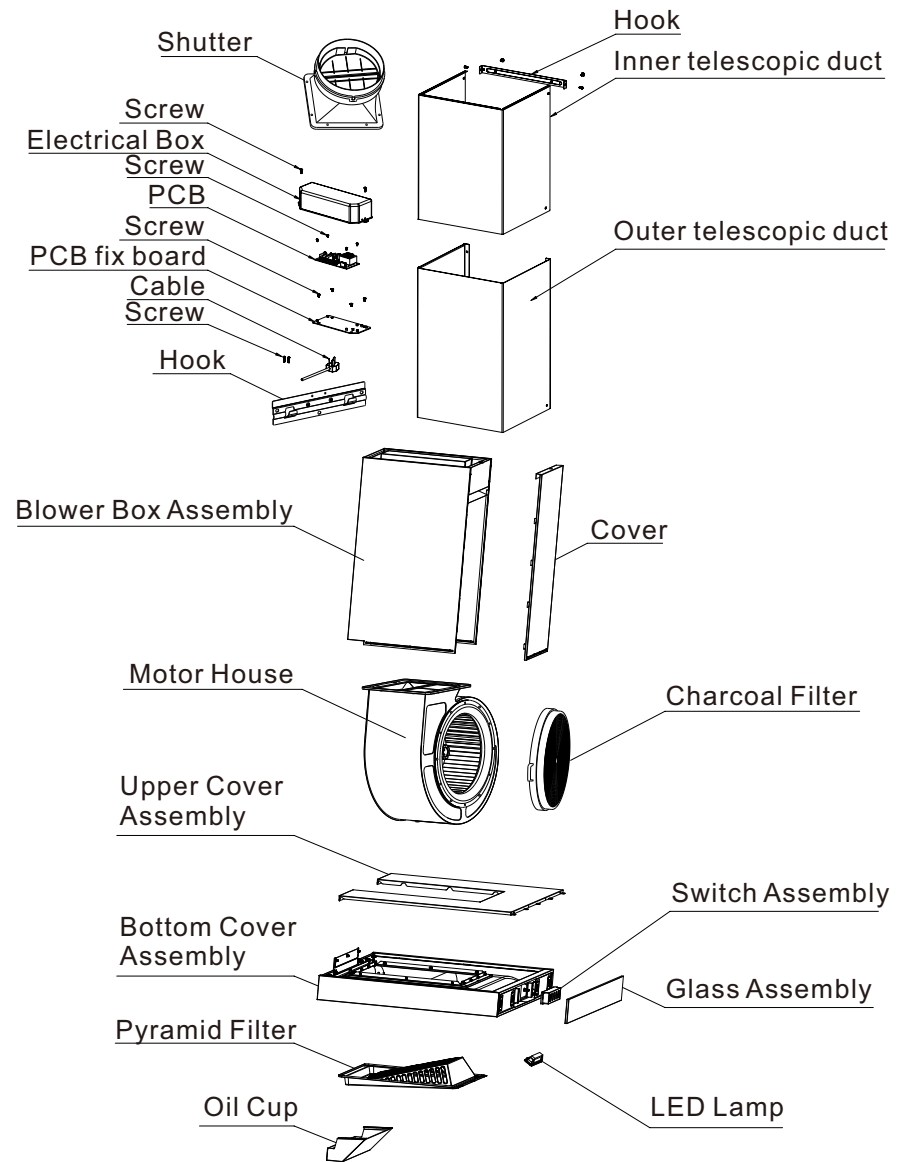

INSTALLATION REQUIREMENT

1. Do not install the cooker hood where there are many doors or windows in order to avoid affecting the exhaust efficiency of the hood caused by air convection. (refer Fig. 1)
2. Install the cooker hood right above the hob. The recommended distance between the hob and the lower edge of the cooker hood is minimum 650 mm and maximum 700mm. (Fig. 2)
3. In order to get the optimum performance, do not elongate the exhaust pipe too long, avoid over-bending of exhaust. Ensure the connection is airtight. (Fig. 3)
4. After hanging the unit on the wall, ensure the hood' level is vertically straight. (Fig. 4)
5. The air outlet must not be connected to chimney flues or combustion gas ducts. The air outlet must be under no circumstances, be connected to ventilation ducts in which fuel-burning appliances are installed.

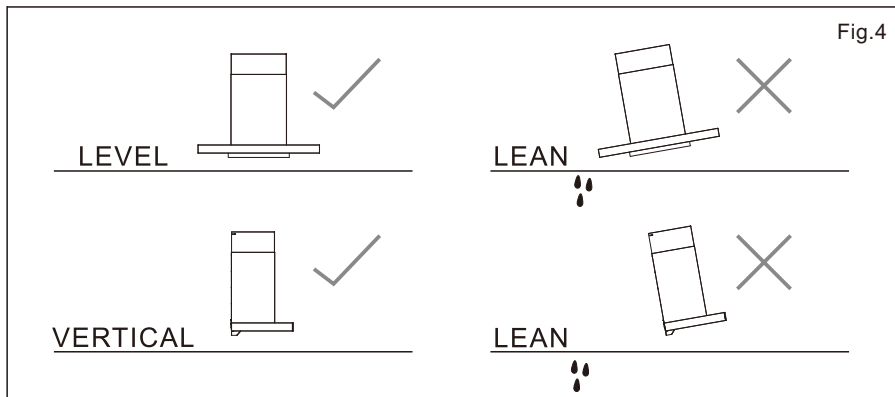
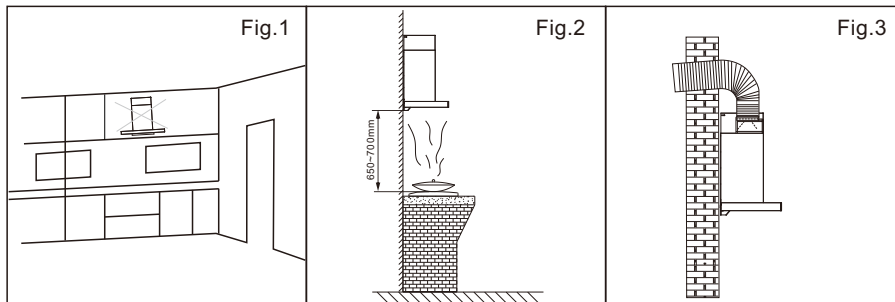

MAINTENANCE

CAUTION: NEVER PUT YOUR HAND INTO THE AREA WHILE THE FAN IS OPERATING. TO GAIN OPTIMAL LEVEL OF HOOD PERFORMANCE, CLEAN THE COOKER HOOD SURFACE, FAN AND OIL FILTER REGULARLY.

1. Use only mild soap or detergent solutions to clean the cooker hood surface.
2. Clean the filter depending to usage or at least once a week. Press the buckle of the filter slightly, take off the filter and put it into warm soapy water using mild detergent, lightly brush the filter with soft brush. Place the filter back after it is dry.
3. Clean the fan motor and others internal parts twice a year or depending to usage by QUALIFIED PERSONNEL.
4. DO NOT clean the motor with water or other liquid.
5. the appliance is not to be used by persons (including children) with reduced physical, sensory or mental capabilities, or lack of experience and knowledge, unless they have been given supervision or instruction.
6. children being supervised not to play with the appliance.
7. there shall be adequate ventilation of the room when the range hood is used at the same time as appliances burning gas or other fuels.

CAUTION: Accessible parts may become hot when used with cooking appliances.

8. The air must not be discharged into a flue that is used for exhausting fumes from appliances burning gas or other fuels.
9. Regulations concerning the discharge of air have to be fulfilled.
10. The range hood is only intended to be installed over a hob with no more than four hob elements.

TO REPLACE LED LAMP

CAUTION: The lamp may be hot! Wait until unit is cool. If the lamps malfunction, please replace it with a new lamp. Make sure all the control is switches off and the cooker hood is unplugged!

Please follow below instructions:

1. Take out the filters, and cut off the wire connection of the lamp.
2. Press the spring according to the arrow direction, then you can take off the lamp unit.
3. You can replace a new LED lamp unit no more than rating!
4. Then put the lamp unit to the hood in reverse direction. Connect the wire of the lamp.
5. Fit on the filters.

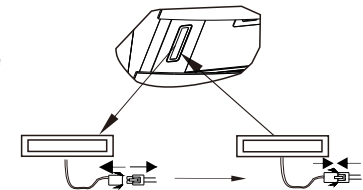

 In the power-off state, press this key enter Auto-clean function, the key lightens and it works 10 minutes then into high speed function 1 minute; Within 1 minute this key keep shining. After the Auto-clean function will have “DING--DONG” sound.
If you want to shut down the Auto-clean function when it is working, there are two ways:(1) press this key to turn off;(2) press the Power key.

 touch to turn on/off the light.

- (1) First power on, in the power-off state, wave two gesture modules from left to right the key lights up. left to right again the air volume from high speed to low speed. Wave two gesture modules from right to left the machine continue to operate 3 minutes. Wave again within 3 minutes to immediately shut down and the light turn off.
- (2) Not the first time, in the power-off state, wave two gesture modules from left to right the power key lights up, remember the last air speed (If the last time is the delay of low speed, not remember, remember the air speed before the delay).
- (3) When the machine work any air speed, wave two gesture modules from right to left the machine enter 3 minutes delay shutdown. wave again within 3 minutes the machine will shut down immediately and the light turn off.
- (4) In the standby mode, wave two gesture modules from right to left the machine will shut down immediately and the light turn off.
- (5) Gesture can't turn on the lighting, but can turn off the lighting.
- (6) When auto-clean, wave two gesture modules left to right or right to left, ineffectively.
- (7) In the power-off state, press the light key 5s, “DING--DONG” sound, this key keep shining 3s (2Hz), the gesture function is closed. Open the gesture function: ① turn it again. ② press the key 5s, “DING--DONG” sound, The lighting flashes 10s (1Hz), gesture function turn on, light recovery.

INSTALLATION PROCEDURES

please carefully read the following diagram before installation, and install in accordance with the steps to ensure the smooth installation of the product.

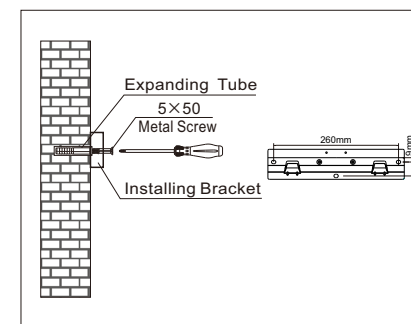
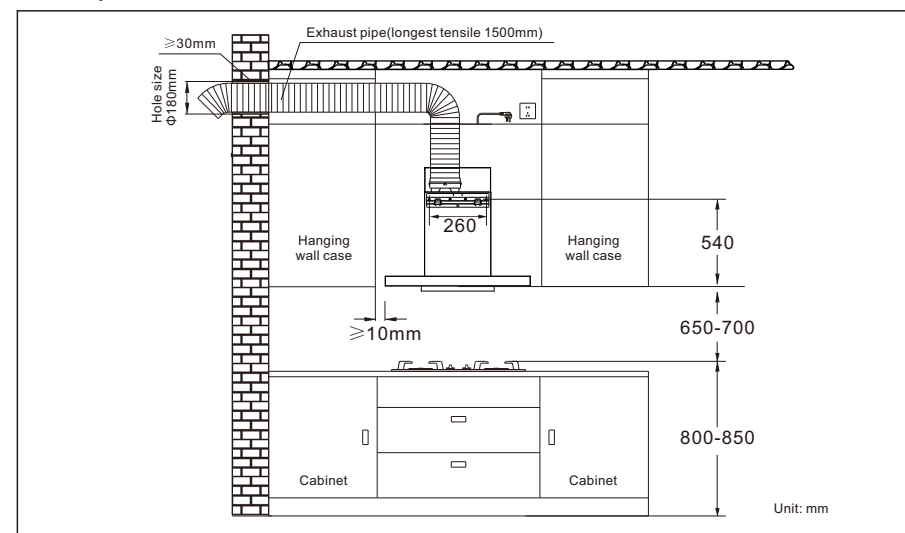

According to the dimension of installing bracket, on the walls in the corresponding position to accurately determine the position of an installing hole, use a $\Phi 10$ impact drilling out the mounting holes, and firmly buried expanding tube, then use the M5x50 wood screws fastening the installing bracket to the wall.

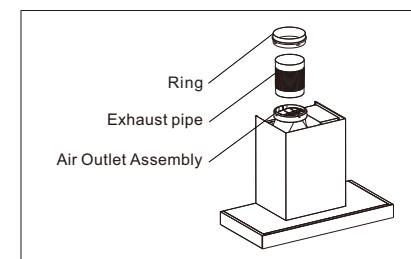

Embed the clasp on the outlet joint with a step at one end, then align the clasp on the outlet and press the clasp to the bottom.

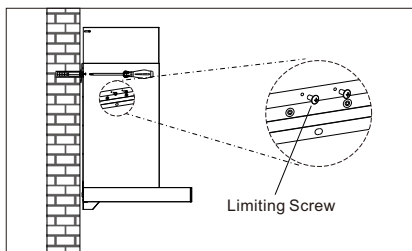

Pick the cooker hood up, the hanging hole at the back of the box assembly is aligned with the hanger on the installing bracket, and the limiting screw in the accessory bag is fixed on the hole of the installing bracket to prevent the accidental fall of the hood.

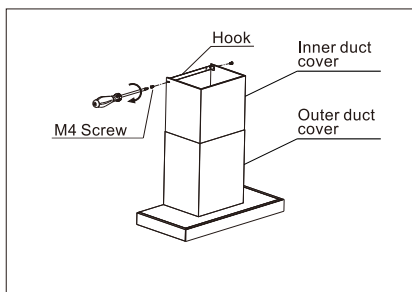

Pull the inner duct cover to a suitable height and secure the inner duct cover from the side to the installation bracket with the cross screwdriver.

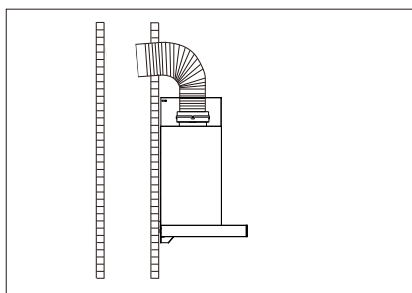

If you need connect the common flue, please do not put the exhaust pipe too deeply, so as to not affect the effect.

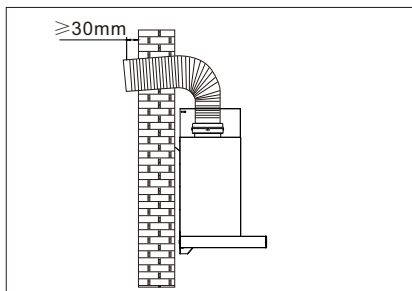

If you connect the exhaust pipe to outdoor, please push it out of the wall at least 30mm, the air outlet should be slightly adown, to avoid rain water intrusion.

Installation confirmation: after installation, check the hood whether it is solid, turn the power on and test it, examine the function whether it is normal and whether there is abnormal vibration of the body, after confirmation, can be used.

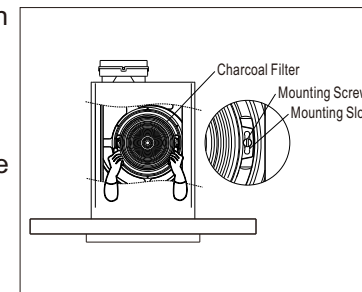

CHARCOAL FILTER INSTALLATION & REPLACEMENT

1. The charcoal filters should be replaced when it is noticeably dirty or discolored, usually after 6 to 12 months depending on the conditions of use.
2. These filters are not washable and cannot be restored. To ensure that this appliance functions effectively, regular maintenance is necessary as clogged filters restrict airflow and may cause the motor to overheat.
3. Removing and inserting the charcoal filter:
Take the baffle filter apart, hold onto the air intakes and turn slightly. Once the charcoal filter turns out of the screw, remove directly.

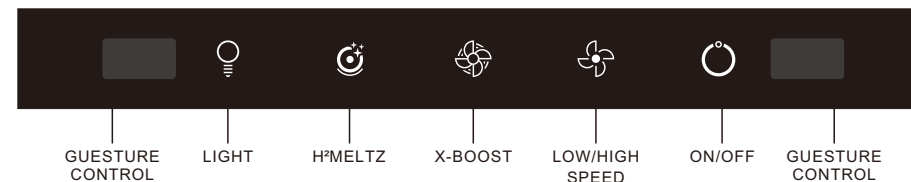

OPERATING INSTRUCTIONS



-  When it is Power-Up state, touch this key into standby mode and the indicator lamp flashes; touch this key again to exit standby mode; At the motor working state, touch this key and the indicator lamp flashes, then the machine continues to operate 3 minutes. After the delay, power will be cut off automatically (including light); at the delay state, touch this key and the power will be cut off (Lighting not included).
-  In the standby mode, Press this key to enter high speed, press again to enter low speed.
-  In the standby mode, touch this key to enter boost function, three minutes later or touch this key again return to high speed; in the motor working state, exit the boost function will return to original speed.